

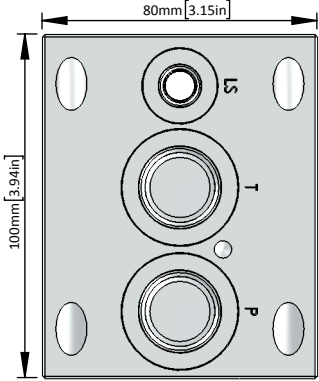

NG10(D05), NG16(D07)
& NG25(D08) Sizes Available
Consult Factory for Details

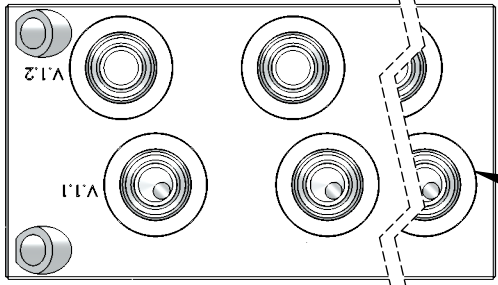

End Bolt Torque
M5 Valve Mounts
35 Nm

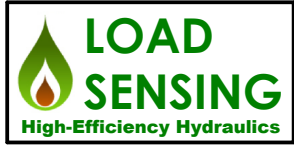
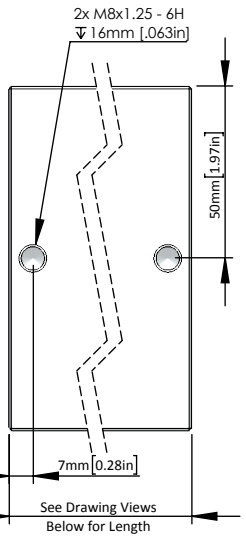
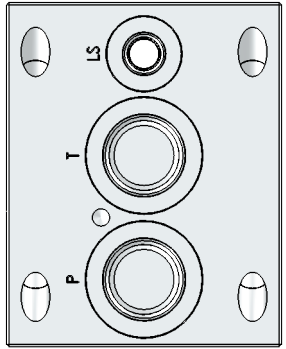
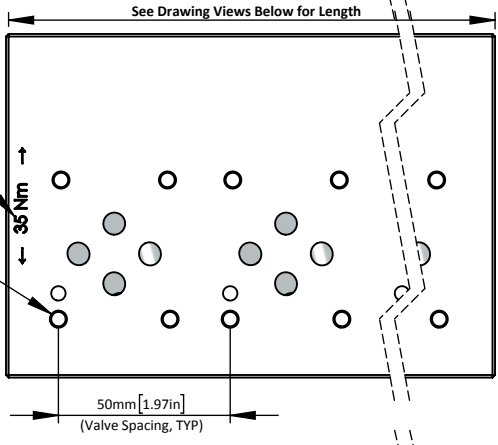

Open Center Auto-LS, Relief, Unloading, Wide Spacing and Other Options Modules Available See Module Section for Details

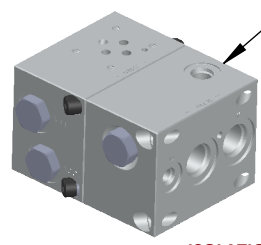

PATENT PENDING

ISOLATIONS:
Zero-Leak 22S-S10 Plugs can be installed between modules in the P and T to create ISOLATIONS as required.

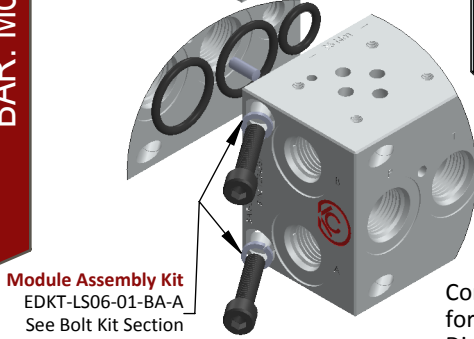
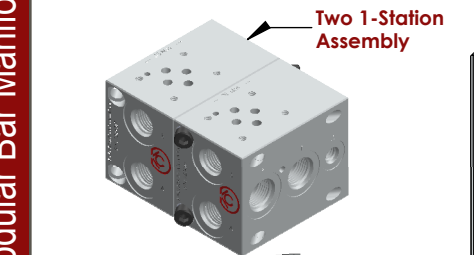
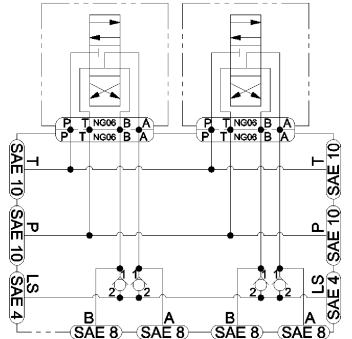

Module Assembly Kit
EDKT-LS06-01-BA-A
See Bolt Kit Section for Details

Consult Factory for All Other Dimensional Data

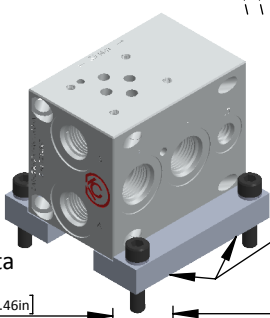

Mounting Kits sold separately See Mounting Kit Section

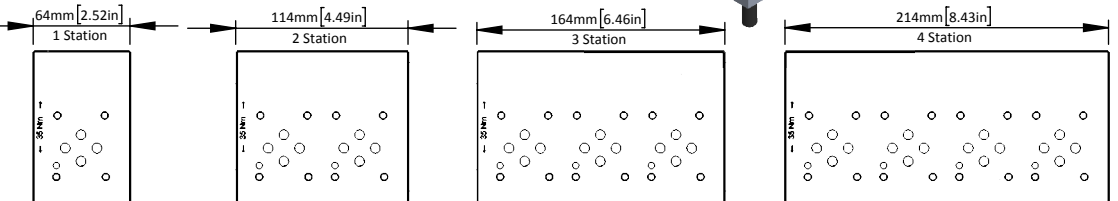

BAR-	LS06-	**-	A-	X-	**-	XX-	A
• Product Family BAR Manifold	• Interface - LS06: NG06 (D03) ISO 4401-03-02-0-0 W/ Load Sensing	• Number of Stations- 01 - 1 Station 02 - 2 Station 03 - 3 Station 04 - 4 Station	• Port Type- A: SAE • P&T: SAE 10 • A&B: SAE 8 • LS: SAE 4	• Relief Cavity- X: None • Available Upon Special Request	• Material • AA: Aluminum • 6061T6 • 210 BAR • DA: Ductile Iron • 654512 • 350 BAR	• Surface Finish XX: Bare Metal • Special Surface Finish Options Available Upon Special Request	• Design Variant A: Design C

BAR: Modular Bar Manifold

BAR: Modular Bar Manifold